

Application Note

ArduiTouch ESP 8266

MODBUS Thermostat



Rev.	Date	Description
A	2018-11-03	First release

1. Introduction

This application note will show you how to make a good-looking touch-screen thermostat with optional Modbus support via RS485 with ArduiTouch ESP and a NodeMCU or Wemos D1 Mini.

2. Bill of Material

- NodeMCU V2 Amica or Wemos D1 mini
- ArduiTouch ESP kit

optional for RS485 interface:

- MAX3485
- transistor BC557
- Resistor 10k
- Resistor 22k
- 2x Resistor 1k
- Resistor 120 Ohm
- Capacitor 1,5nF
- 2pole header
- Jumper bridge

3. RS485 circuit

The ArduiTouch itself doesn't contain a RS485 interface. We have to add this function on the breadboard area.

Beside the breadboard area you will find soldering pads with all needed signals. You have only to connect the circuit below with these soldering pads. For the A and B signals it's recommend to use the pads 3 and 4 which are directly connected to the terminal.

Please note: The jumper must be open for programming of the ESP8266 module via USB.

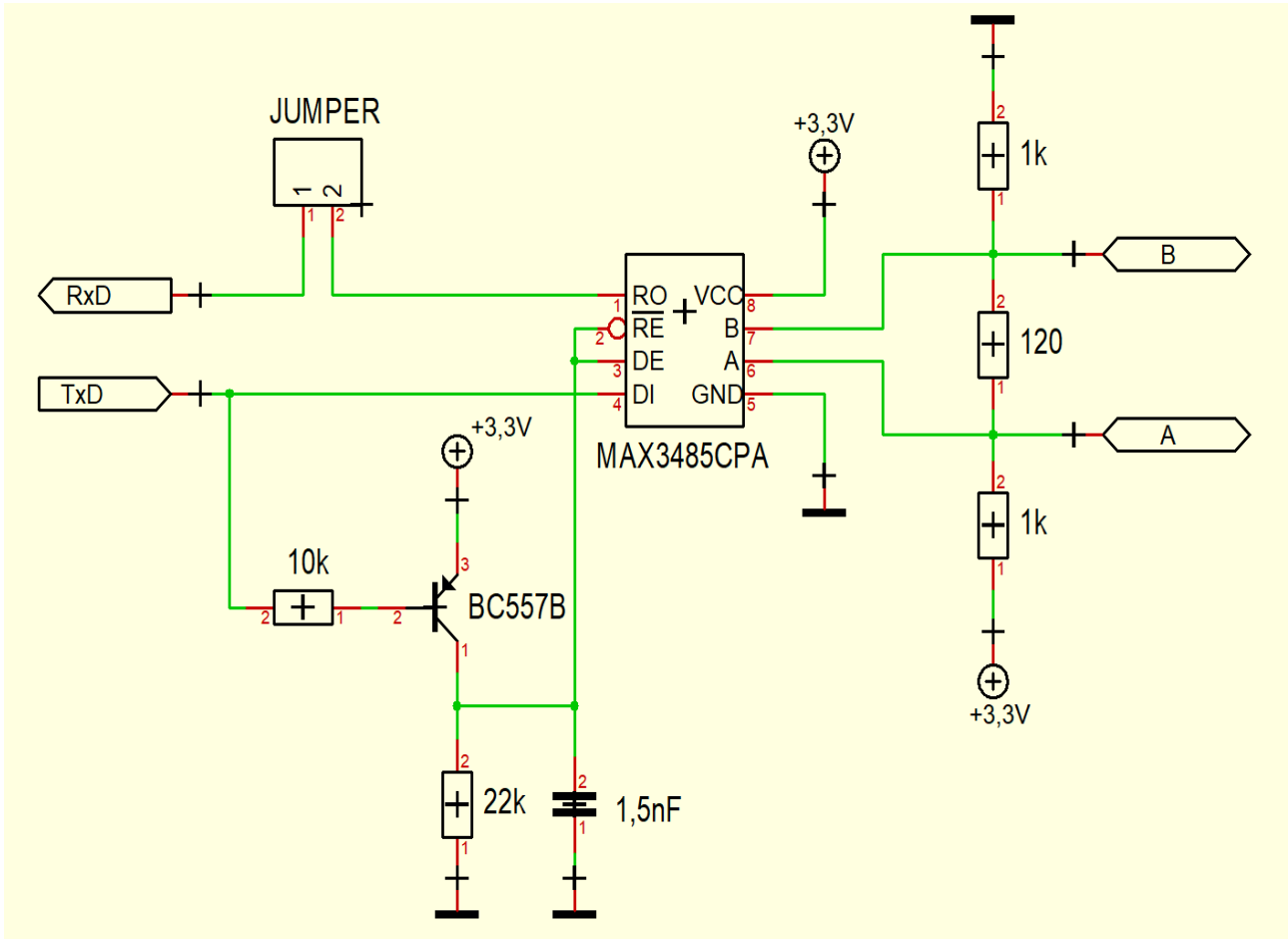

Fig 1: Additional circuit for RS485 support

4. Install the USB drivers for NodeMCU or Wemos D1

The NodeMCU module includes a CP2102 chip for the USB interface. Usually the driver will be installed automatically if the NodeMCU is connected the first time with the PC. Sometimes this procedure failed. In this case you have to install the driver

<http://www.silabs.com/products/development-tools/software/usb-to-uart-bridge-vcp-drivers>

manually in the Windows device manager.

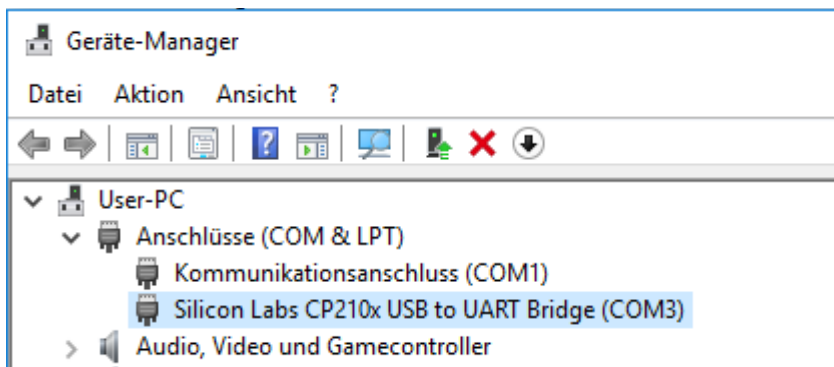

If you want to use the Wemos D1 you have to install the drivers for the CH340 USB interface instead:

http://www.wch.cn/download/CH341SER_ZIP.html

5. Preparation of Arduino IDE for ESP8266

The ESP8266 module isn't part of the Arduino-IDE. We have to install it first.

Open **file / preferences** in the Aduino-IDE and insert the following link in the **Additional Boards Manager URLs field**:

http://arduino.esp8266.com/stable/package_esp8266com_index.json

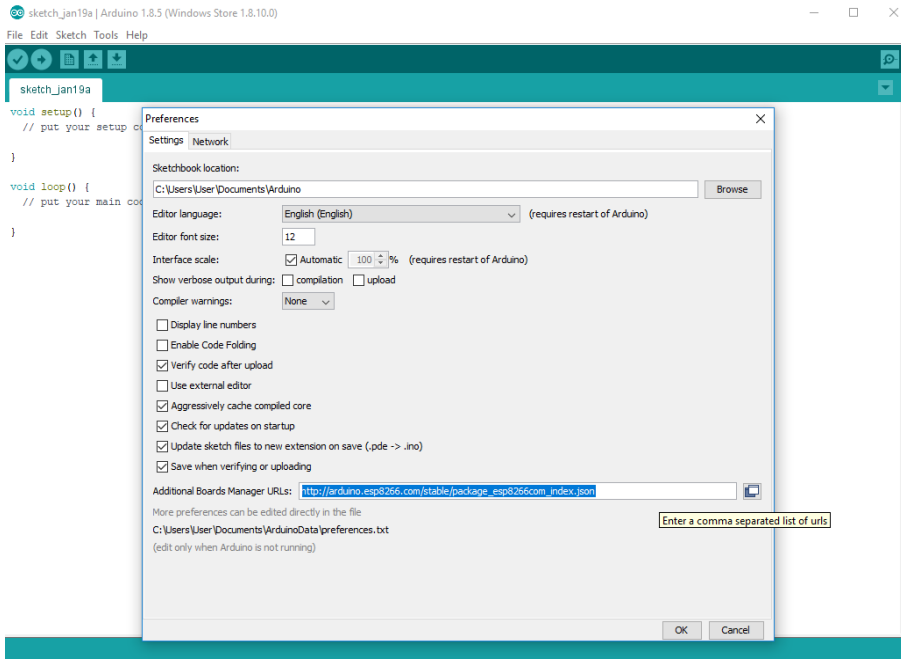

Close this window with the OK Button.

Open now the board manager: **Tools / Board / Board Manager**

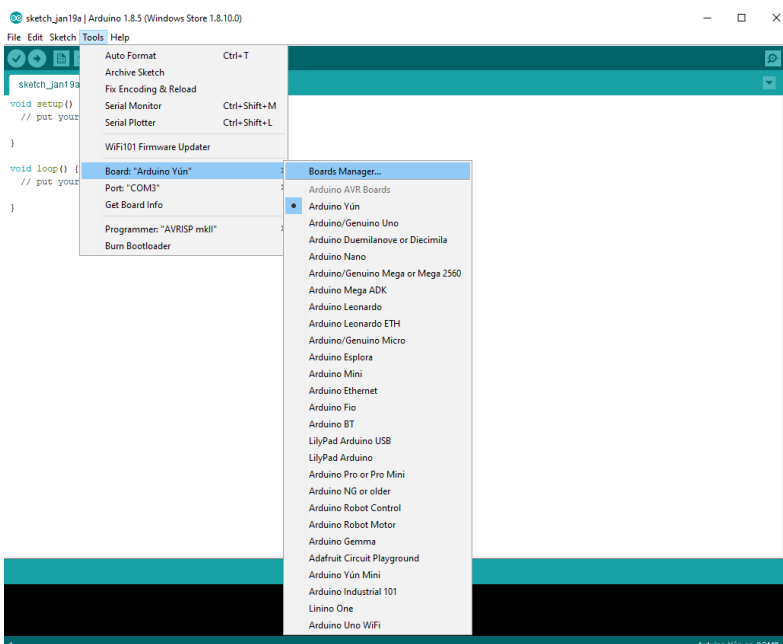

Go to the **ESP8266** entry and install it:

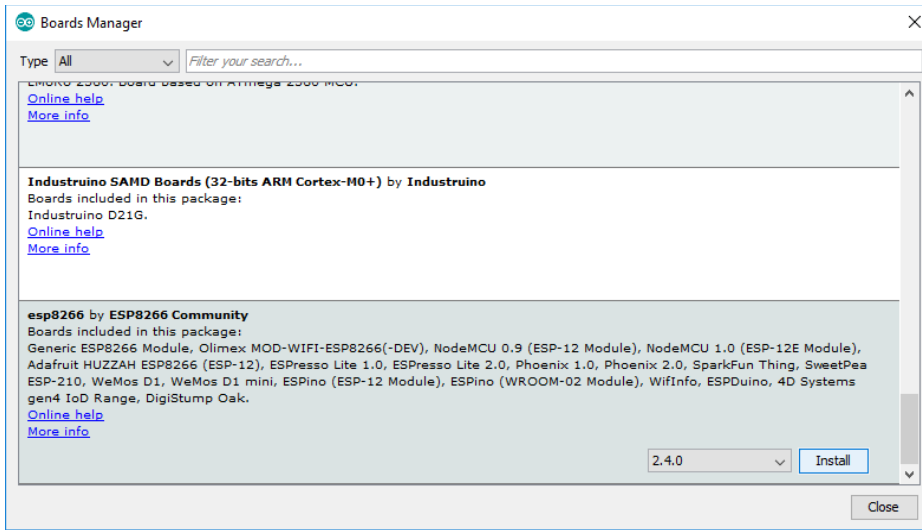

Now you can choose **NodeMCU 1.0 (ESP-12E Module)**. Set the CPU frequency to 80MHz, Flash Size to „4M (3M SPIFFS)“, the baud rate of your choice and the COM port.

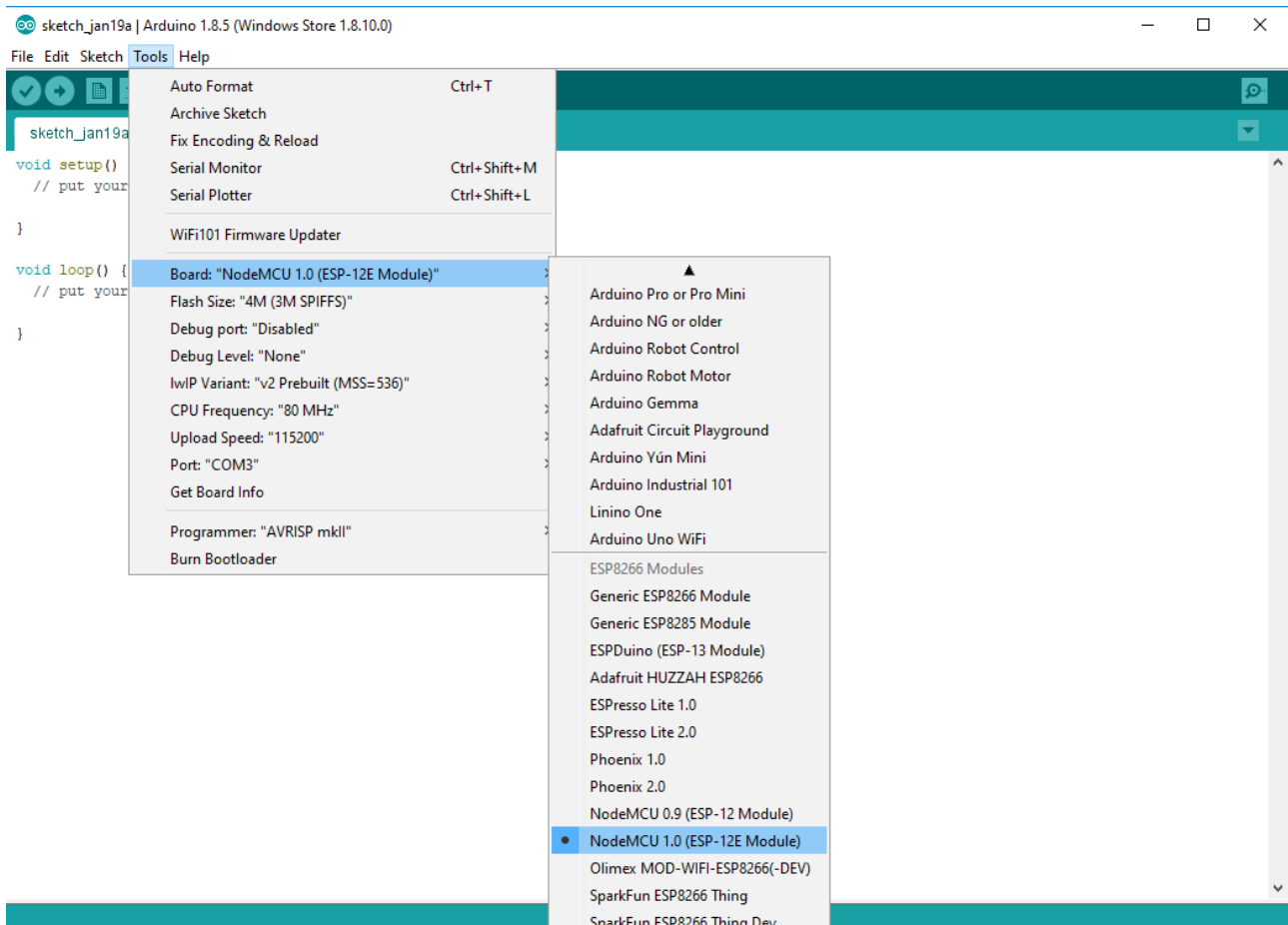

For the Wemos D1 Mini you have to choose **WeMos D1 R2 & mini**. Set the CPU frequency to 80MHz, Flash Size to „4M (3M SPIFFS)“, the baud rate of your choice and the COM port.

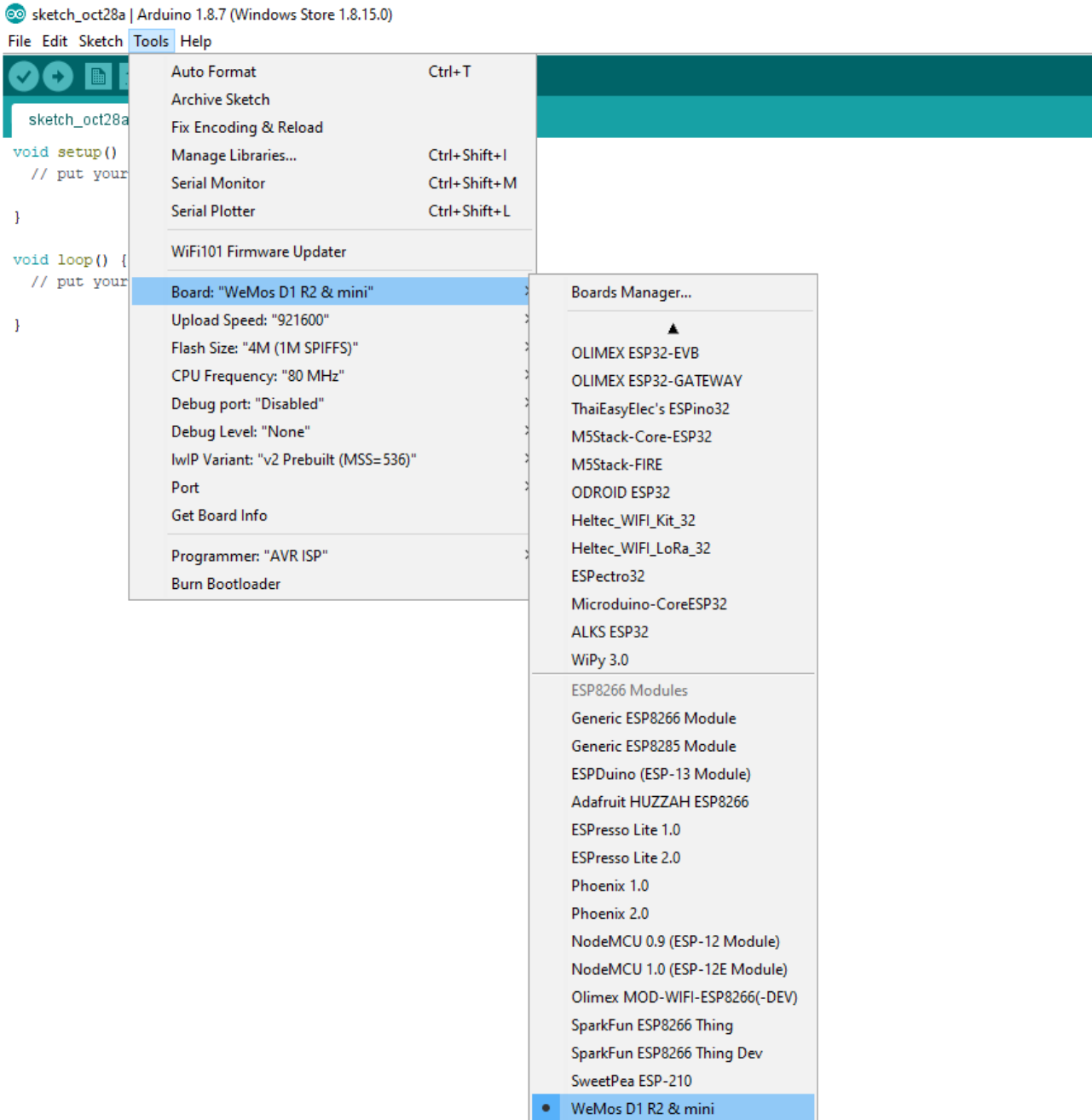

6. Programming

6.1 Installation of additional libraries

Install the following libraries through Arduino Library Manager

Adafruit GFX Library

<https://github.com/adafruit/Adafruit-GFX-Library/archive/master.zip>

Adafruit ILI9341 Library

https://github.com/adafruit/Adafruit_ILI9341

XPT2046_Touchscreen by Paul Stoffregen

https://github.com/PaulStoffregen/XPT2046_Touchscreen/blob/master/XPT2046_Touchscreen.h

SimpleModbus NG

<https://github.com/angeloc/simplemodbusng>

You can also download the library also directly as ZIP file and uncompress the folder under yourarduinodesketchfolder/libraries/

After installing the Adafruit libraries, restart the Arduino IDE.

6.2 Source Code

You will find the source code on our website.

<https://www.hwhardsoft.de/english/projects/arduitouch-esp/>

6.4 Run the demo

Please open this sample in the Arduino IDE. Compile and upload it.

Please note: The jumper must be open for programming of the ESP8266 module via USB.

After compilation and upload you will see the Main screen with default values for room temperature, set temperature and ventilation. You can change the set temperature and ventilation level without RS485 connection also.

You can open via the gear in the upper right corner an option menu. This menu includes a function to adjust the Modbus ID number and a screen cleaning function.

6.5 Modbus test

We will use in this example the PC as MODBUS master. You've to download Modbustester. Please unpack the zip archive to a new directory on your haddisk. Open the software and change the marked fields as in the picture above. You have to connect the USB-RS485-adaptor before. For simple tests a serial connection via USB cable between your PC and the NodeMCU will also work. Please choose the right COM-port for this adaptor in Modbustester.

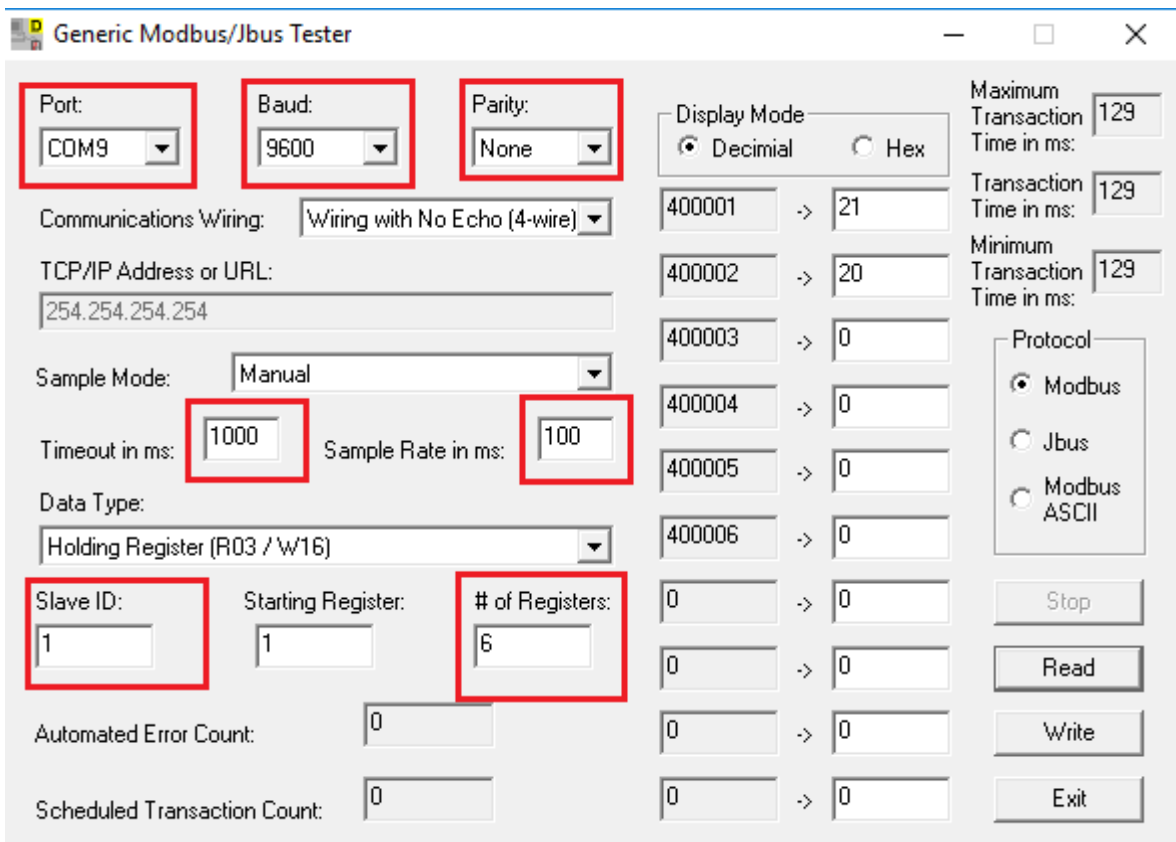

Fig 2: Modbustester

You can press the Read button in Modbustester. This command will read 6 bytes of the memory of our new slave device the ArduiTouch. You can click also in the fields beside the addresses and manipulate the values. With the write button you send this manipulated values to the ArduiTouch. Please see the table below about the register function.

Application Note: ArduiTouch ESP 8266 HVAC Rev A

Register	Variable	Description
400001	ROOM_TEMP	measured room temperatur from external sensor (values 5 - 50)
400002	SET_TEMP	set-point temperature by user (values 18 - 28)
400003	FAN_LEVEL	level for ventilation (values 0 - 5)
400004	BEEPER	any value between 500 and 4000 will set the beeper with the given frequency for 100ms
400005	DISP_ONOFF	timer for display automatic off function (0 switch backlight off, >0 set timer for automatic)
400006	TOTAL_ERRORS	Counted communication errors